

Direct Vent Gas Fireplaces

# FINE DESIGNS TO SUIT ANY STYLE

 MONESSEN



# LET YOUR FIREPLACE LIGHT UP YOUR STYLE

You know what you like. That's why Monessen direct vent gas fireplaces are available in a variety of designs. From specialty and contemporary options to more traditional, there's a model designed to reflect your style. Discover all your options and find the right Monessen fireplace for you.



Serenade shown with Stone Studio Surround. (pg.12-13)  
Cover: Covington shown with Cottage Clay Firebrick

# ALL OUR DIRECT VENT GAS MONESSEN FIREPLACES OFFER GREAT FEATURES LIKE THESE.

## CHECK OUT THE VIEW

Designed to deliver a beautiful flame picture, all our fireplaces provide an expansive view of the fire that will delight friends and family.

## COZY COMFORT

No matter which style you choose, you can be sure everyone will cozy up to our Monessen fireplaces that deliver ample BTUs to help heat your home.

## EXCLUSIVE SIGNATURE COMMAND™ SYSTEM

Enjoy the ultimate in fireplace control, featuring a touch screen remote\* and 3-step flame height adjustment. With electronic ignition, this system lights the pilot only when you turn it on to help save energy. And, with automatic battery back-up, you can be assured of fireplace operation even if the power goes out.

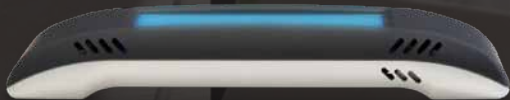

Look for Total Signature Command™ on select models, featuring the exclusive Smart Mode® thermostat for enhanced energy efficiency, rear burner shut down and more!

**READ MORE ABOUT SIGNATURE COMMAND™ OPTIONS ON THE BACK COVER!**

\*Available with select fireplaces. Signature Command™ not available with the Lexington Fireplace.

## SERIOUS EFFICIENCY

With a CSA rating of 85%, this fireplace doesn't mess around when it comes to providing efficient heat to almost any room. Finish the look to your taste with a variety of design options.

### HBDV SERIES QUICK LOOK

Sizes	33", 36"
Heating Capacity	1,000 – 1,200 sq. ft.
Max BTUs	16,000 – 27,000
Thermal Efficiency	Up to 85%
Control System	Signature Command™



### ADDITIONAL FEATURES

- Ceramic Glass
- Deluxe Illustrated Control Panel
- Mesh Glass Cover also available

### DESIGN OPTIONS

#### Interior Firebrick



Cottage Clay



Cottage Red

#### Finishing



Stainless Steel Louvers



Black and Stainless Trim available in Medium (shown) and Curved styles



HBDV Series shown with Cottage Clay Firebrick

## EXPRESS YOUR CLASSIC STYLE

With a range of more traditional design options, like louvers, arched fronts and doors, you can achieve a classic look that becomes a centerpiece of style for your home. Plus, the large format provides a wide viewing area that showcases the dancing flames from anywhere in the room.

### MANCHESTER QUICK LOOK

Sizes	42", 47"
Heating Capacity	1,500 - 1,600 sq. ft.
Max BTUs	21,500 - 32,000
Thermal Efficiency	Up to 80%
Control System	Signature Command™



### DESIGN OPTIONS

#### Interior Firebrick



Cottage Clay



Cottage Red

#### Finishing



Stainless Steel Louvers

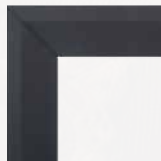

Black and Stainless Trim available in Medium (shown) and Curved styles



### FINISHING OPTIONS

Available in Black Texture and Iron Age:

- Filigree Panels and Mesh Glass Cover also available (not pictured)



- Arched Fronts

- Cabinet Door Frame

Cabinet Doors with Screen



Manchester shown with Cottage Clay Firebrick



Winchester shown with Vintage Brown Herringbone Firebrick

## SIMPLE CHIC, EXPANSIVE VIEW

The clean face design of this fireplace provides contemporary styling with an air of understated elegance, plus a wide viewing area. Complete with a robust, premium log set, the Winchester is a stunning addition to your home.

### WINCHESTER QUICK LOOK

Sizes	42"
Heating Capacity	1,500 – 1,660 sq. ft.
Max BTUs	22,000 – 34,000
Thermal Efficiency	Up to 80%
Control System	Signature Command™



### DESIGN OPTIONS

#### Interior Firebrick



Cottage Clay



Cottage Red



Vintage Brown  
Herringbone

Mesh Glass Cover also available (not pictured)

## GET THE REAL DEAL

Enjoy the most realistic gas fire available, thanks to the exclusive LexFire Burn System™. Featuring varying flame height and glowing logs, it mimics the natural progression of a wood burning fire for a truly authentic presentation. Plus, the Lexington Series offers unique finishing options to complete your look.

### LEXINGTON QUICK LOOK

Sizes	32", 36"
Heating Capacity	1,520 – 1,950 sq. ft.
Max BTUs	22,000 – 44,000
Thermal Efficiency	Up to 80%
Control System	Standard Millivolt Control



Lexington shown with Nantucket Rectangular Front in Vintage Iron



## DESIGN OPTIONS

### NANTUCKET RECTANGULAR FRONTS

Black *(Not available with doors)*



Textured Black



Vintage Iron



### NANTUCKET ARCHED FRONTS

Black *(Not available with doors)*



Textured Black



Vintage Iron with Fire Screen Doors



### LEXINGTON ARCHED FRONTS *(Also available in Black)*

Textured Black with Fire Screen Doors in Vintage Iron



Vintage Iron with Fire Screen Doors in Vintage Iron



## EXCLUSIVE LEXFIRE BURN SYSTEM™

So realistic, you'll forget it's not real wood.

Featuring:

- Glowing, hand-carved logs
- Bright yellow flames
- Realistic ember bed
- Unparalleled flame pattern and realism (the hallmark of the LexFire Burn System™)
- Precise combustion and airflow

Visit [monessenhearth.com](http://monessenhearth.com) to learn more about the LexFire Burn System™

## ADDITIONAL FEATURES

- Heat Activated Blower Standard
- Remote Ready
- Variable Flame Control
- Ceramic Glass with Quick Release Latch
- Deluxe Control Panel
- Built-in Adjustable Flue Restrictor
- High Altitude Kit optional

## THE CLEAR CHOICE FOR BIG STYLE

The clean face design and wide open flame presentation of this taller fireplace fills the impressive firebox for a truly stunning view. Non-reflective ClearView ceramic glass ensures that no one has to strain to see the fire's glow from any angle, while the included accent light complements the beautiful design. In addition, rear burner shut off reduces BTUs, so you can enjoy the look of a great fire on milder evenings, without as much heat.

QUICK LOOK	COVINGTON	COVINGTON SEE-THRU
Sizes	44", 48", 60"	48"
Heating Capacity	1,800 – 3,100 sq. ft.	2,700 – 2,780 sq. ft.
Max BTUs	28,500 – 60,000	44,000 – 56,000
Thermal Efficiency	Up to 85%	Up to 80%
Control System	Total Signature Command™ also available in Millivolt Control	Total Signature Command™



Covington shown with Vintage Brown Herringbone Firebrick





Covington See-Thru shown with Cottage Red Firebrick, Stainless Steel Outdoor Facing Kit and Cast Andirons



Covington See-Thru shown with Vintage Brown Herringbone Firebrick and Cast Andirons

## DOUBLE TAKE

This specialty option gives you a double dose of the beautiful, clean-face design of our Covington fireplace. Viewable from two rooms at once, the two non-reflective ceramic glass sides provide a "pass through" effect, while the ability to install on an exterior wall allows you to add dramatic effect to both indoor and outdoor settings. For ambiance without as much heat, use the center burner shut off to reduce BTUs.

### SPECIALTY MODEL

## DESIGN OPTIONS FOR COVINGTON AND COVINGTON SEE-THRU

### Interior Firebrick



Cottage Clay



Cottage Red



Vintage Brown Herringbone

### Finishing



Decorative Black Texture Door



Forged Andirons 13"



Cast Andirons 12"



Cast Andirons 16"  
KHLDV600 Models Only

COVINGTON SEE-THRU

## LOVELY, ANY WAY YOU LOOK AT IT

With three different configuration options, the Arlington Designer Series adds a dramatic accent to any room. Each style allows you to view the fire from multiple sides, while interior options like contemporary glass and stone and light kits transform your fireplace into a statement piece, even when it isn't lit.

### SPECIALTY MODEL

#### ARLINGTON QUICK LOOK

Sizes	See-Thru, Corner, Peninsula
Heating Capacity	1,450 – 1,780 sq. ft.
Max BTUs	25,000 – 37,000
Thermal Efficiency	Up to 80%
Control System	Signature Command™



#### DESIGN OPTIONS

##### Interior Firebrick



Cottage Red



Vintage Brown Herringbone

Black Porcelain Liner and Accent Light also available (not pictured)

##### Fireglass

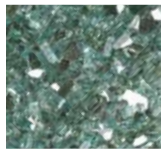

Emerald



Sapphire



Onyx

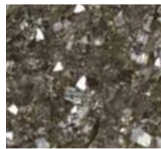

Bronze

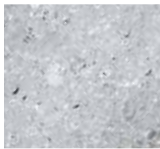

Diamond



Contemporary Stone with Bronze Glass Ember Bed (standard)

Note: Glass kits include one 2.25 lb. bag. Designer units require 2 bags.

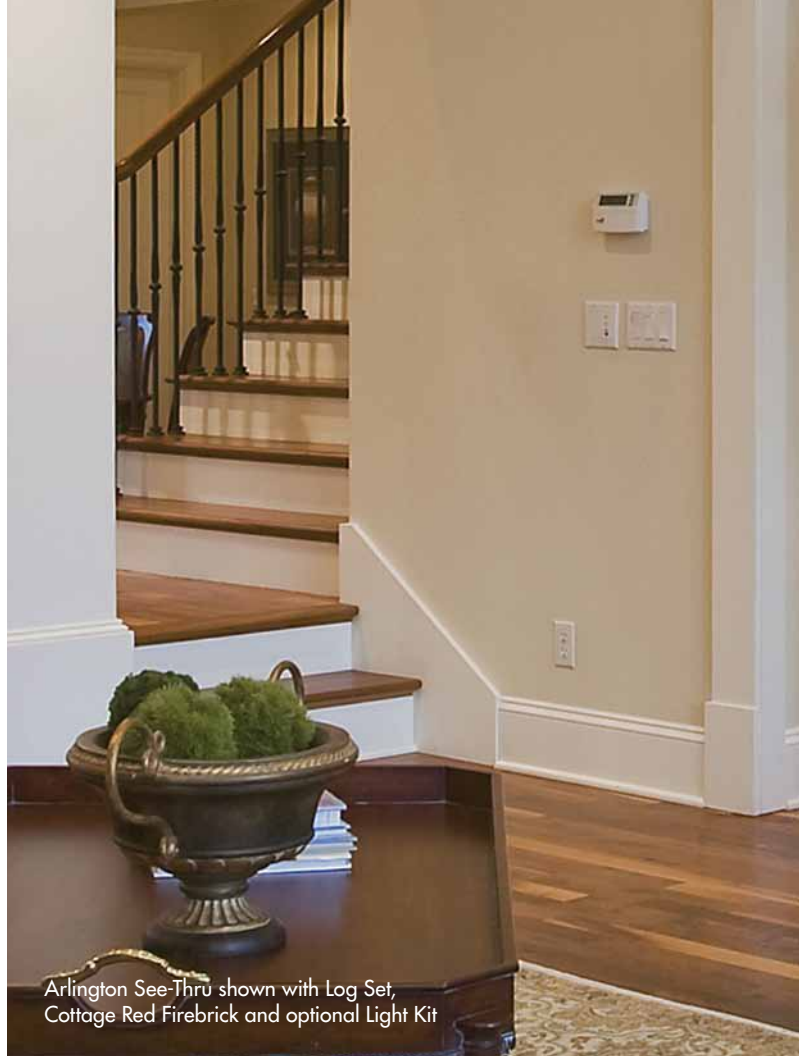

Arlington See-Thru shown with Log Set, Cottage Red Firebrick and optional Light Kit



Arlington Corner shown with Porcelain Panels and Contemporary Stone and Glass



Arlington Peninsula shown with Log Set, Cottage Red Firebrick, Barrington Dark Walnut Cabinet and optional Accent Light

Note: Cabinet available for Peninsula model only. See Cabinet dimensions on page 15.



# SERENADE

## LUXURY YOU'LL LOVE

Offering the very latest in contemporary styling, the Serenade is truly a luxury fireplace, featuring a linear format and beautiful ribbon flame. Accented with unique finishing options like our gorgeous Stone Studio Surround, this fireplace is truly a work of art. And with our Glass Illumination Light System, the Serenade continues to entertain, even when it isn't lit.



Serenade shown with Textured Black Surround and Contemporary Stone Kit - Also available in Iron Age.

# SERENADE SEE-THRU

## DESIGNER'S DREAM

Combining the Serenade fireplace's contemporary, wide-open style with the dynamic look of a see-thru fireplace, this is the ultimate in designer fireplaces. Plus, it can be installed between two interior rooms or on an exterior wall, making it the only linear fireplace on the market to offer this versatile installation feature.

**SPECIALTY MODEL**

Serenade See-Thru shown with Stone Studio Surround and Contemporary Stone Kit





Serenade shown with Contemporary Stainless Steel Surround and optional Aged Driftwood Log Set



Serenade shown with Black Trim Kit.

### QUICK LOOK

	SERENADE	SERENADE SEE-THRU
Sizes	42", 60"	42"
Heating Capacity	1,400 – 2,000 sq. ft.	1,300 – 1,330 sq. ft.
Max BTUs	23,000 – 45,000	23,000 – 34,000
Thermal Efficiency	Up to 80%	Up to 80%
Control System	Total Signature Command™	Total Signature Command™



### DESIGN OPTIONS FOR SERENADE AND SERENADE SEE-THRU

Finishing	42" WDV500	60" WDV600	See-Thru 42" WDVST500
Black Trim	Available	Available	Available
Stone Studio Surround	Available	—	Available
Stainless	Available	Available	Available
Textured Black	Available	Available	Available
Iron Age	Available	Available	Available
Outside Stainless Steel Trim	—	—	Available for installation on exterior wall
Porcelain Panels	Optional	Standard	Standard
Stone and Glass Kit	Standard	Standard	Standard
Aged Driftwood Log Set	Optional	Optional	Optional
Quick Latch System	Yes, Ceramic Glass	Yes, Anti-Reflective Glass	Yes, Ceramic Glass



### Fireglass

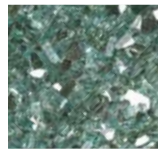

Emerald

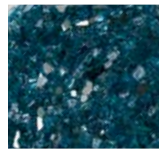

Sapphire

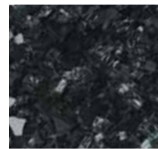

Onyx



Bronze

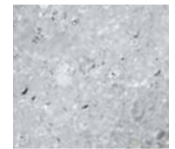

Diamond



Contemporary Stone with Bronze Glass Ember Bed (standard)



Aged Driftwood Log Set



Serenade See-Thru shown with Outdoor Glass Facing Kit

Note: Fireglass kits include one 2.25 lb. bag. WDV500 and WDVST500 require two bags. WDV600 requires three bags.

## MONESSEN DIRECT VENT SYSTEMS LINEUP

MODEL	HBDV		MANCHESTER		WINCHESTER	LEXINGTON	
SIZES	33"	36"	42"	47"	42"	32"	36"
Model #s	HBDV300	HBDV400	MDV500	MDV600	MLDV500	LX32	LX36
Standout Feature	AFUE-rated fireplace for superior efficiency		Wide viewing area and multiple finishing options		Clean face design and premium log set	Exclusive LexFire Burn System™	
Control System	Signature Command™		Signature Command™		Signature Command™	Millivolt Control	
Max heating capacity (sq ft)	1,100	1,200	1,500	1,600	1,660	1,520	1,950
Viewing style	Front		Front		Front, Clean Face	Front	
Maximum viewing area (sq in)	538	652	764	903	922	762	810
Max BTU/h*	23,000	27,000	30,000	32,000	34,000	36,000	44,000
Thermal efficiency	Up to 85%	Up to 85%	Up to 80%	Up to 80%	Up to 80%	Up to 80%	Up to 80%
Burner system	Natural Flame		Natural Flame		Natural Flame	LexFire Burn System™	
AFUE Efficiency	Up to 65%	Up to 66%	Up to 64%	N/A	N/A	N/A	N/A
FE Ratings (Canada)	67.4% NG 75.7% LP	70.9% NG 74% LP	Up to 82%	Up to 74%	Up to 76%	66.1% NG 66.2% LP	66.8% NG 69.1% LP
Dimensions (Actual)	33 1/16" W 37 7/8" H 15" D	37 1/16" W 41 1/2" H 18 1/4" D	41" W 40 3/8" H 20 3/4" D	47" W 40 3/8" H 20 3/4" D	41" W 50 3/4" H 22 1/4" D	39" W 46 1/2" H 21 3/4" D	43" W 46 1/2" H 21 3/4" D
Dimensions (Framing)	33 1/2" W 38" H 13 3/4" D	37 1/2" W 41 5/8" H 16 1/2" D	42" W 46 1/2" H 20 3/8" D	48 1/16" W 46 1/2" H 20 3/8" D	42 1/2" W 50 7/8" H 22 1/4" D	41 1/16" W 47 5/8" H 21 3/4" D	45 1/16" W 47 5/8" H 21 3/4" D
ACCESSORIES							
Remotes	Optional		Optional		Optional	Thermostat Controls Optional	
Blower Kits	Optional		Optional		Optional	Standard	
Field Fuel Conversion Kit	Available		Available		Available	Available	

Orange indicates upgrade from previous model.

\*For natural gas models.

All Monessen Direct Vent Fireplaces in this catalog are CSA Design Certified and available in both natural gas and LP configurations.

Remotes and thermostats are available for all models for added convenience.



Touch screen hand held ON/OFF remote. A Touch Screen remote comes standard with Total Signature Command™ models.



Thermostat ON/OFF remote control with 3-step flame height adjustment and 3-step blower control with receiver



Programmable wireless wall thermostat with receiver

COVINGTON			COVINGTON SEE-THRU	ARLINGTON	SERENADE		SERENADE SEE-THRU
44"	48"	60"	48"	36" SPECIALTY	42"	60"	42"
KHLDV400	KHLDV500	KHLDV600	KSTDV500	STLDV, PFLDV, CLLDV, CRLDV	WDV500	WDV600	WDVST500
Non-reflective, ClearView ceramic glass			Specialty design lets you view the fire from two rooms at once	3 different configurations for versatile style and installation options	Ultra-contemporary wide view design and the latest technology		The first linear fireplace on the market that can be installed on an exterior wall for an indoor-outdoor view
<b>Total Signature Command™</b>			Total Signature Command™	Signature Command™	<b>Total Signature Command™</b>		Total Signature Command™
2,100	2,500	3,100	2,780	1,780	1,430	2,000	1,330
Front, Clean Face			See-Thru	See-Thru, Corner, Peninsula	Front, Clean Face		See-Thru
960	1,080	1,500	2,160	2,771	497	648	990
40,000	50,000	60,000	56,000	37,000	34,000	45,000	34,000
Up to 80%	Up to 80%	Up to 85%	Up to 80%	Up to 80%	Up to 80%	Up to 80%	Up to 80%
—	—	—	—	—	—	—	—
N/A	N/A	66% NG 66% LP	67.4% NG 66.3% LP	67.01% NG 68.28% LP	N/A	65.9% NG 66.1% LP	Up to 80%
Up to 82%	Up to 78%	81.0% NG 80.0% LP	77.3% NG 74.3% LP	69.7% NG 79.4% LP	64.4% NG 67.7% LP	70.2% NG 72.2% LP	61.0% NG 59.7% LP
44 15/16" W 44 3/8" H 23 7/8" D	48 15/16" W 44 3/8" H 23 7/8" D	55" W 50 15/16" H 24 1/4" D	49 1/2" W 44 1/2" H 24" D	See Thru: 49 7/16" W x 47 7/8" H x 24" D Corner: 46 3/8" W x 47 7/8" H x 24" D Peninsula: 46 3/8" W x 47 7/8" H x 24" D	46 1/8" W 35 7/16" H 18 3/16" D	57 1/8" W 35 7/16" H 18 15/16" D	51 1/4" W 38 3/8" H 17 3/8" D
45 5/16" W 44 3/4" H 23 7/8" D	49 3/16" W 44 3/4" H 23 7/8" D	55 1/2" W 50 9/16" H 24 1/2" D	50" W 44 3/4" H 23" D	See Thru: 50 1/16" W x 48 3/16" H x 23" D Corner: 46 5/8" W x 48 3/16" H x 27 7/8" D Peninsula: 46 5/8" W x 48 3/16" H x 23" D	46 5/8" W 35 5/8" H 17 7/8" D	57 5/8" W 35 5/8" H 18 5/8" D	51 3/4" W 38 1/2" H 17 3/8" D
Optional			Optional	Optional	Touchscreen remote included		Touchscreen remote included
Optional			Optional	Optional	Optional		Optional
Available			Available	Available	Available		Available

**Barrington Cabinet Option for Pearl Peninsula (SGP36)**

See Cabinet on page 11.

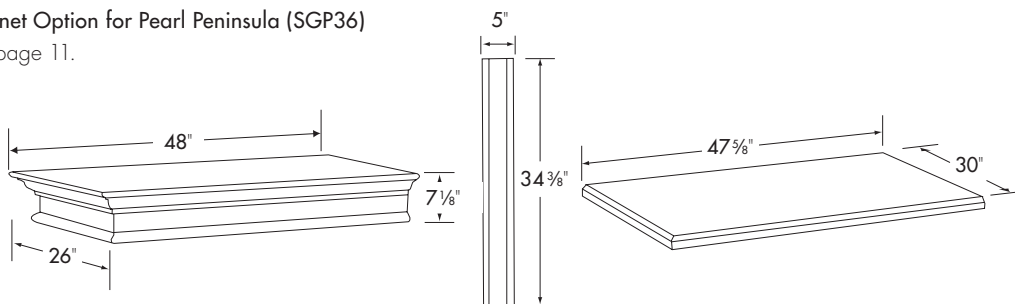

# ULTIMATE CONVENIENCE AT YOUR FINGERTIPS

Our direct vent gas fireplaces offer two  
**Exclusive Signature Command™ Systems.**

Discover the level of control that's right for you!

## Signature Command™ System

An A/C adaptor is included; however, unlike competing control systems that require A/C to function, the Signature Command™ System can be installed where no power is available, making it more convenient than ever to enjoy the fire.

### Featuring:

- ON/OFF 3-step variable flame height adjustment
- Automatic, uninterrupted battery back-up during power outages
- Pilot selection option — choice of cold climate standing pilot or the energy efficient intermittent pilot
- Memory shut off remembers your favorite setting the next time the fireplace is turned on
- Convenient diagnostic code indication lights
- Built-in remote receiver for the option to easily add a remote control

## Total Signature Command™ System

Enjoy the convenience of a technologically advanced and energy efficient fireplace control system!

### Featuring:

All of the features included with Signature Command™ System

### PLUS:

- Smart Mode® thermostat for enhanced energy efficiency — it automatically adjusts flame height and/or blower to maintain the desired temperature, using only the energy it needs to help save on fuel costs.
- TSFSC Full Function Touch Screen remote control
- Rear burner shut down feature lowers heat output as much as 70% for ambiance when heat is not needed (on select fireplaces)
- A/C accessory model for added control features, like household lighting, waterfall feature, and more!



LOVE AT FIRST LIGHT

A Brand of Monessen Hearth Systems Co.  
149 Cleveland Drive, Paris, Kentucky 40361  
monessenhearth.com

Your Monessen Dealer:



To avoid personal injury or property damage, the product described by this brochure must be installed, operated and maintained in strict compliance with the instructions packaged with the product and all applicable building or fire codes. Contact local building or fire officials about restrictions and installation inspection requirements. All photographs and drawings on this brochure are for illustrative purposes only and are not intended for, nor should they be used as a substitute for the instructions packaged with the unit. Appearance and specifications of the product are subject to change without notice.  
©2011 Monessen Hearth Systems Co. 11115\_1011 MON1211 Ver.01

For more information about MHSC and Monessen efficient and environmentally friendly products, please visit [monessenhearth.com](http://monessenhearth.com)